

DURATIQ
Engineered for you

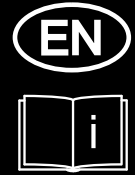

User Manual
HTC DURATIQ
T5



Translation of manual in original language

DURATIQ

Engineered for you

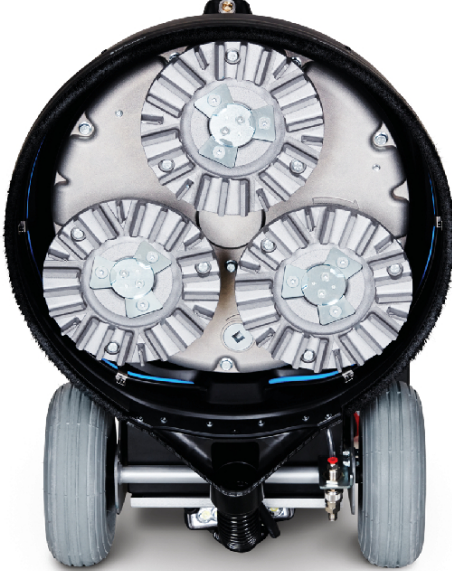

Contact information

HTC Sweden AB

Box 69

SE-614 22 Söderköping - Sweden

Tel: +46 (0) 121-294 00

Fax: +46 (0) 121-152 12

www.htc-floorsystems.com

Trademarks

HTC is a trademark owned by HTC Sweden AB. Other names and products mentioned in this manual may be registered trademarks owned by the relevant companies.

© 2018 HTC Sweden AB. All rights reserved.

EC Declaration of conformity

Manufacturer:	HTC Sweden AB Box 69 SE-614 22 Söderköping Sweden +46 (0)121-29400
Type of equipment:	Grinding machine
Make:	HTC
Trademark:	HTC DURATIQ 5
Year of manufacture:	See machine name plate
Serial number:	See machine name plate

Original of the EC declaration of conformity (Swedish). Other languages are translations of the original of the EC declaration of conformity.

Söderköping 01/06/2016



Peter Lundgren
Development Manager
HTC Sweden AB



Björn Jeansson
Product Manager
HTC Sweden AB

Standards

As the manufacturer, we hereby declare under our sole responsibility that the above product with serial numbers from 2018 and onward conforms to the applicable regulations in:

EN 60335-1:2012	Household and similar electrical appliances - Safety - Part 1: General requirements.
EN 60335-1:2012 + A11:2014	Household and similar electrical appliances - Safety - Part 1: General requirements.
EN 60335-2-72:2012	Household and similar electrical appliances - Safety - Part 2-72: Particular requirements for floor treatment machines with or without traction drive, for commercial use.
EN 62233:2008	Measurement methods for electromagnetic fields of household appliances and similar apparatus with regard to human exposure.
EN 61000-6-4:2007 + A1:2001	EMC
FCC CFR 47 Part 15 (2016)	EMC
EN 61000-6-2 (2005)	EMC
DIRECTIVE 2006/42/EC	Machinery directive.
DIRECTIVE 2014/30/EC	EMC
DIRECTIVE 2014/35/EC	LVD

ISO 5349-1:2001	Mechanical vibration -- Measurement and evaluation of human exposure to hand-transmitted vibration -- Part 1: General requirements.
ISO 5349-2:2001	Mechanical vibration -- Measurement and evaluation of human exposure to hand-transmitted vibration -- Part 2: Practical guidance for measurement at the workplace.
ISO 20643:2005	Mechanical vibration -- Hand-held and hand-guided machinery -- Principles for evaluation of vibration emission.
ISO 11202:2010	Acoustics -- Noise emitted by machinery and equipment -- Determination of emission sound pressure levels at a work station and at other specified positions applying approximate environmental corrections.

The product was CE marked 2018. The technical documentation is available from the manufacturer.

Table of contents

1	Introduction.....	9
1.1	General.....	9
1.2	Liability.....	9
1.3	Warranty	9
2	Safety.....	10
2.1	Symbols that are used.....	10
2.2	Safety rules.....	10
3	Information about the machine.....	13
3.1	Unpacking the equipment.....	13
3.2	Transport	13
3.2.1	Transport	14
3.2.2	Lifting.....	14
3.3	Storage.....	14
3.4	Machine name plate	15
3.5	Hand and arm vibrations	16
3.6	Sound power level	16
4	Machine description.....	17
4.1	General machine description.....	17
4.2	Control cabinet	21
4.3	Control panel (HMI)	22
4.4	Information Panel	24
4.5	Connection Panel	27
5	Operation.....	28
5.1	General.....	28
5.2	Handle setting.....	28
5.3	Handling weights	31
5.4	Cable and Hose Strain Relief Device	32
5.5	Separate grinding head and chassis	33
5.6	Access to Grinding Tools.....	35
5.7	Fitting Grinding Tools.....	35
6	Grinding.....	37
6.1	Grinding by machine.....	37
6.2	Emergency Stop Switch	38
6.3	Making Operation Easier	38
6.4	DURATIQ Remote connectivity	40
7	Accessories	43
7.1	Water package.....	43
7.1.1	Mist Cooler System	43
7.1.2	Wet grinding	44
8	Maintenance and repair	46
8.1	General.....	46
8.2	Cleaning	46
8.3	Prior to each new grinding process	47
8.4	During operation.....	47
8.5	Daily.....	47

8.6	Every week	47
8.7	Repairs	47
8.8	Spare parts.....	48
8.9	Warranty	48
9	Troubleshooting.....	49
9.1	General.....	49
9.2	The machine will not start.....	49
9.3	Fuse or earth fault breaker trip frequently	50
9.4	The machine cannot cope	51
9.5	Warnings and Error Messages	51
9.5.1	Warnings	51
9.5.2	Error Messages	54
10	Technical Data	56
11	Environment.....	58
11.1	Chassis.....	58
11.2	Grinding head.....	58
11.3	Electrical system	59
11.4	Recycling.....	59

1 Introduction

1.1 General

HTC's machines are used for processing floor surfaces. The machine's area of application depends on the choice of tool.

In addition to use and general functions, this manual explains the applications and maintenance of your HTC machine. Contact your local retailer for further information. For contact information, see the start of the manual.

1.2 Liability

Even though every effort has been made to make this manual as complete and accurate as possible, we bear no responsibility for incorrect or missing information. HTC reserves the right to change descriptions in this manual without giving prior notice.

This manual is protected by the Copyright Act and no part of it may be copied or used in any other way without the written approval of HTC.

1.3 Warranty

This warranty only covers manufacturing defects. HTC bears no responsibility for damage that arises or occurs during transportation, unpacking or use. In no instance and under no circumstances shall the manufacturer be held responsible for damage and defects caused by incorrect use, corrosion or use outside the prescribed specifications. The manufacturer is not responsible for indirect damage or costs under any circumstances. For complete information on the manufacturer's warranty period, see HTC's current warranty terms.

Local distributors may have special warranty terms specified in their terms of sale, delivery and warranty. If there is any uncertainty regarding warranty terms, please contact your retailer.

2 Safety

This chapter includes the safety rules that must be observed when using HTC's machines.

2.1 Symbols that are used

The symbols below are used in this manual to show the need for extra care when using the machine.



WARNING

This symbol means **Warning!** and indicates a risk of personal injury or material damage.

If the warning is not observed, this could result in death or serious personal injury.



NOTE

This symbol means **Note!** and indicates a risk of material damage in the event of incorrect use.



TIP

This symbol means **Tips!** and indicates tips and advice on effective use of the machine or ways of reducing wear and tear to the machine.

2.2 Safety rules

Users of machines from HTC have the ultimate responsibility for ensuring that everybody who works with or in the vicinity of the equipment follow all applicable safety rules. Safety measures must meet the requirements that apply for this type of equipment. Apart from the standard rules that apply in the workplace, the recommendations in this manual shall also be observed.

All work must be performed by trained personnel. Users of machines from HTC must have read through the dedicated manual for the machine. Incorrect use of the equipment could result in situations that could cause harm to the operator, the surroundings or the machine.

**WARNING**

Training is required.

Risk for personal injury and mechanical damage.

Children should be kept under supervision to prevent them from playing with the machine.

The machine must not be operated by children or in the vicinity of children. The machine must not be used by those with impaired physical, sensory or mental abilities or by those who lack the knowledge that is required for using the machine.

Machines from HTC may only be used in the way recommended by HTC.

Machines from HTC may only be used for commercial purposes.

The machine is only tested for use up to 2000 metres above sea level.

Anyone using the machine shall know about:

- its functions
- location of emergency stops
- the safety rules for the work

The operator shall ensure that:

- no unauthorised person is within the work area when the machine is started up

The workplace shall:

- be suitable for the purpose
- be secured from loose objects that can be thrown out by the machine
- be free from protruding bolts etc. on the surface to be processed

Individuals in the workplace shall always use the recommended personal protective equipment and wear suitable clothing:

- safety goggles
- protective gloves
- steel toe safety shoes
- hearing protection
- respiratory mask
- do not wear loose fitting clothing or anything that can catch, such as scarves, bracelets, rings, etc.

General precautions:

- Check the machine is connected to an earthed wall socket.
- Work on live parts shall only be performed by qualified personnel.
- Suitable fire extinguishers shall be clearly marked and close to hand.

- Maintenance of the equipment must not be performed during operation.



	⚠ DANGER
	HIGH VOLTAGE Disconnect power before servicing.
	⚠ WARNING
	To reduce the risk of fire, use only commercially available floor cleaners and waxes intended for machine application.
	⚠ WARNING
	Risk of explosion. Floor sanding can result in an explosive mixture of fine dust and air. Use floor sanding machine only in well ventilated area.
	⚠ CAUTION
	Moving Parts – To reduce the risk of injury, unplug before servicing.

G003338

This information decal is affixed clearly visible on the machine's electrical cabinet.

3 Information about the machine

3.1 Unpacking the equipment

Check the packaging and equipment carefully on delivery for any possible transport damage. If there is any sign of damage, contact the retailer and report the damage. Report packaging damage to the transport company as well.

Check that the delivery matches the order. If there are any questions, contact the retailer.

3.2 Transport

**WARNING**

Risk for personal injury and mechanical damage

**NOTE**

During moving, transport and lifting, the weights shall be in position 1, see Handling Weights.

3.2.1 Transport

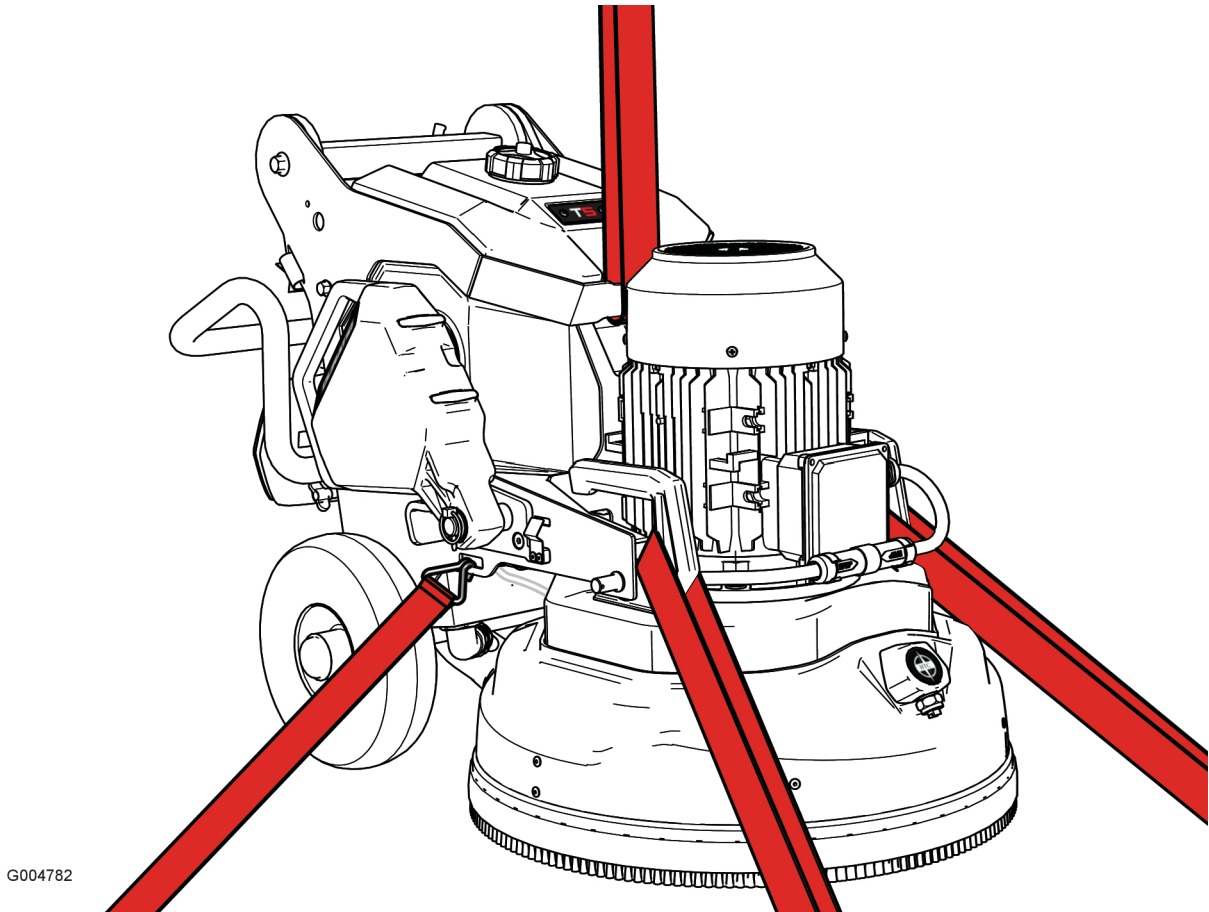

Always make sure that the machine is securely anchored to its surroundings and that the grinding head is lowered on to the surface. Tighten the securing straps, or other equipment used for anchoring during transport over non-moving parts, e.g. the machine's chassis.

3.2.2 Lifting

The machine can be lifted using the lifting eyes provided and a lifting strap. The weights should be in position 2 and the handle in position 4, see Handling weights page [31](#) and Handle setting page [28](#).

3.3 Storage

The machine should be stored in a heated, dry area when not in use. It may be damaged by condensation and cold.

3.4 Machine name plate

The machine name plate provides the following information. The model and serial number must be specified when ordering spare parts for the machine.

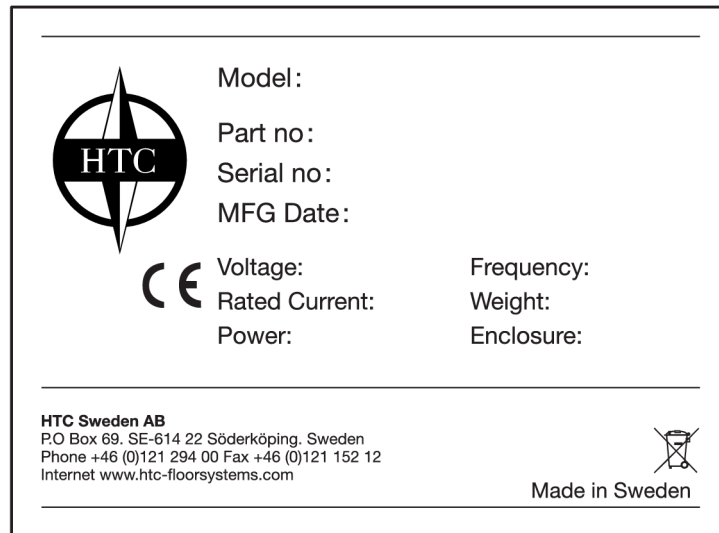

G004756

Name	Description
Model	Model
Part no	Part number
Serial no	Serial number
MFG date	Date of manufacture
CE	Approved standards. Only one example is shown here, the machine name plate shows the correct approved standards. See also Standards page 5
Voltage	Voltage (VAC)
Rated current	Current (A)
Power	Power (kW/hp)
Frequency	Frequency (Hz)
Weight	Weight (kg/lbs)
Enclosure	IP class
	Recycling, see Recycling page 59

3.5 Hand and arm vibrations

Hand and arm-weighted vibration levels [m/s²] for HTC DURATIQ have been measured using equipment approved in accordance with ISO 5349-1:2001. The uncertainty of measurement for the measuring equipment is given as $\pm 2\%$.

The machine has been tested in accordance with ISO 5349-2:2001 and ISO 20643:2005 in order to identify the operations that contribute to the most frequent vibration exposures. At vibration levels > 2.5 m/s² the exposure time should be limited in accordance with the table below. For vibration levels > 5 m/s² immediate measures must be taken by the employer to ensure that the exposure time does not exceed the time specified in the table below.

Identified work conditions	Measured values [m/s ²]	Daily permitted exposure (number of hours)
Grinding/polishing	< 2.5 m/s ²	> 10 h

3.6 Sound power level

This machine has been tested for noise in accordance with ISO 11202.

Measured using class 1 instruments as sound level meters. For information about sound level power, see chapter Technical Data page 56.

4 Machine description

4.1 General machine description

A grinding machine from HTC has been developed for processing various types of floor. It is used to grind, coarse grind, prepare and polish concrete, natural stone and terrazzo floors or other materials specified in this manual as recommended by HTC.

The machine is constructed from a number of main components, see below.

The handle can be set in several different positions.

The machine's grinding head is covered by a sloping hood, which provides a close fit to the floor. The cover together with the connected vacuum system provide the conditions needed for a good work environment. The cover ensures that the operator does not come into contact with rotating mechanical parts and exposure to dust is minimised. Because the cover is floating, the dust uptake is optimised since it is always in contact with the surface.

Always make sure that a dust extractor is connected to the grinder during dry grinding to prevent as far as possible exposure to dust particles of operators, people in the vicinity, the grinder and other equipment.



WARNING

Dust.

Risk for personal injury.

The dust that is sucked up may be harmful if inhaled. Follow local regulations and use breathing protection.

The machine can be easily equipped with a large number of tools, depending on the floor material to be ground. For more information about different tools, see HTC's website www.htc-floorsystems.com.

Some grinding machines can be equipped with a Mist Cooler system for effective cooling of the grinding tools. This system enables a very fine water mist to be diffused through a nozzle over the floor surface, which cools the tools and thereby makes the grinding more effective.



G004761

No.	Description	Accessories
1	Water tank	Water package
2	Machine cover	
3	Motor connector	
4	Nozzle for Mist Cooler System	Water package
5	Handlebar	
6	Handlebar locking rough adjustment	
7	Handlebar locking fine adjustment	
8	Lifting point	
9	Weight	Weight unit



G004762

No.	Description	Accessories
1	Control panel	
2	Handle	
3	Handle lock, Allen, 5 mm	
4	Electrical connection	
5	Connection, dust extractor, camlock, male 2	
6	Water connection, quick release	Water package

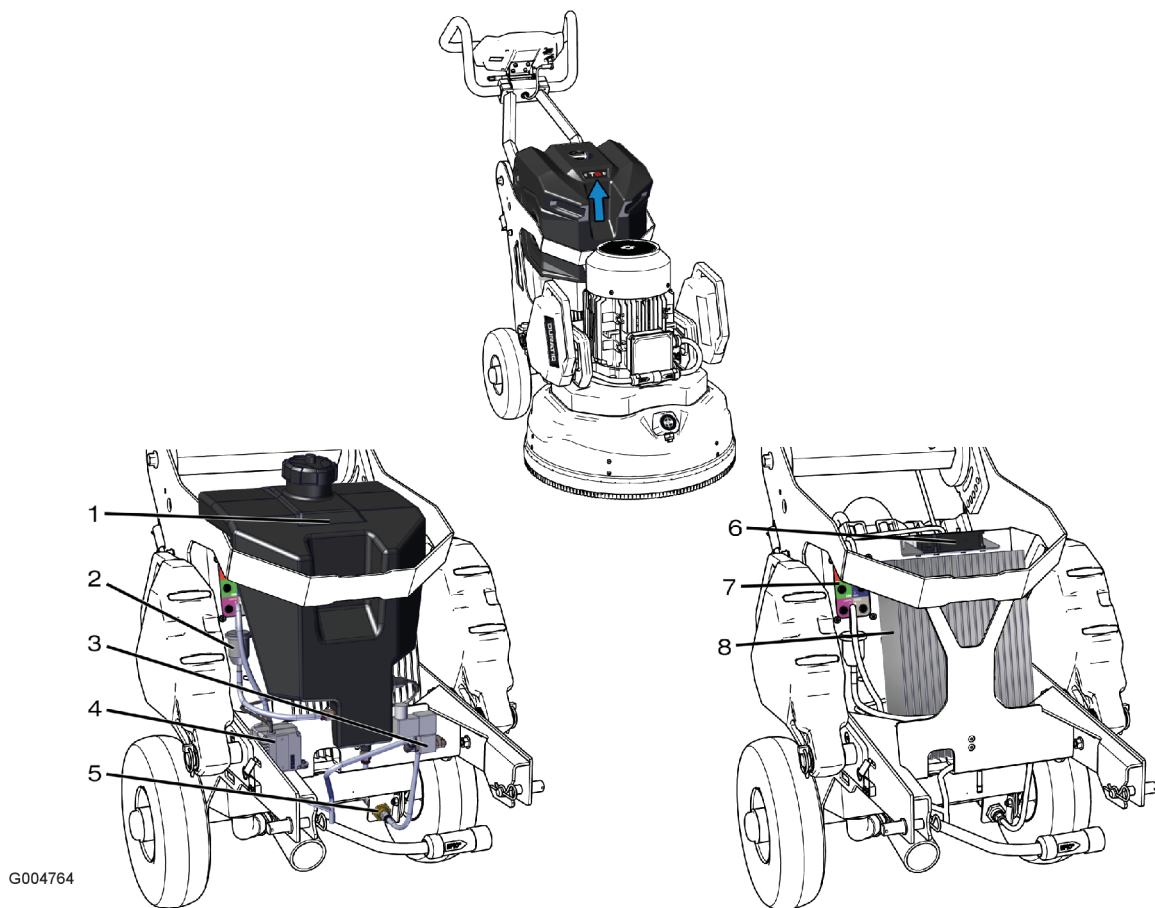

G004764

No.	Description	Accessories
1	Water tank	Water package
2	Filter Mist Cooler System	Water package
3	Pump Mist Cooler System	Water package
4	Water, quick release	Water package
5	Cooling fan	Cooling unit
6	Connection panel for accessories	
7	Cooling flange	

4.2 Control cabinet

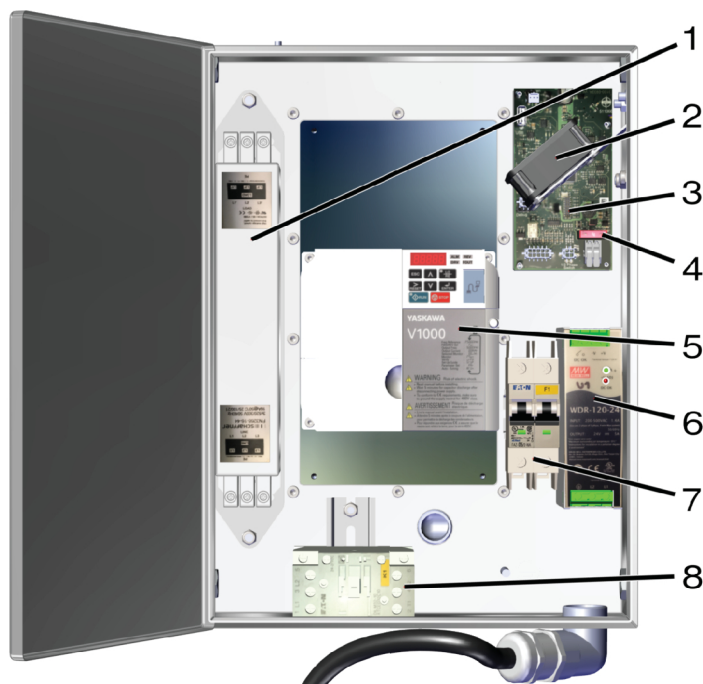

G004766

No.	Designation	Description	Accessories
1	Z1	EMC Filter	
2	FN1	Cooling fan	Cooling unit
3	EB1	Mainboard	
4	F2	Fuse 4A, 24 V	
5	U1	Frequency Converter	
6	U2	Power Supply	
7	F1	Miniature circuit breakers 2 x 5A for Power Supply	
8	K1	Contact	

4.3 Control panel (HMI)

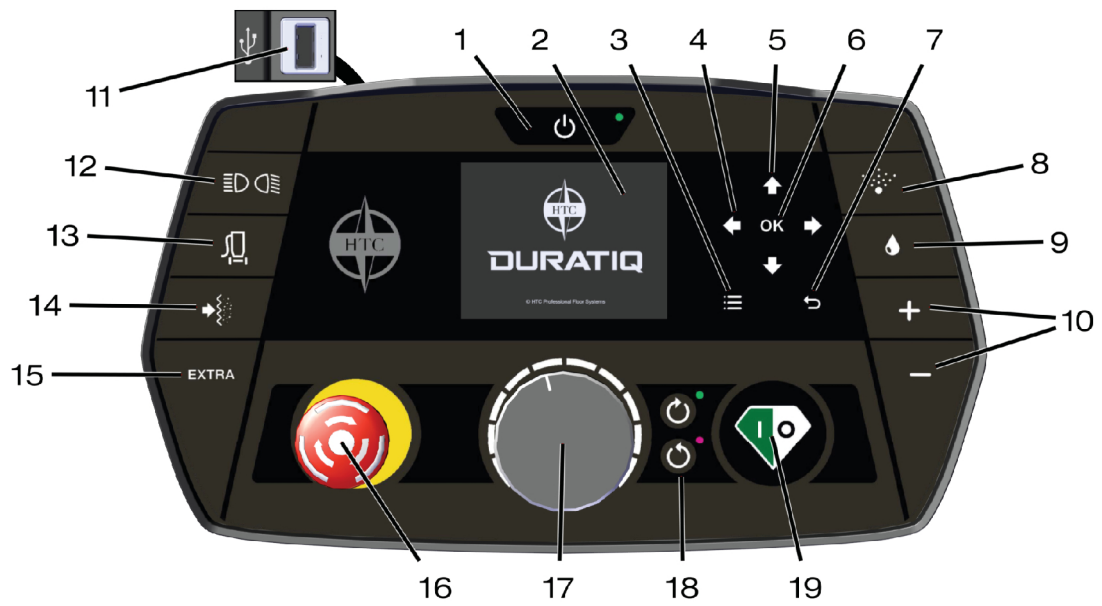





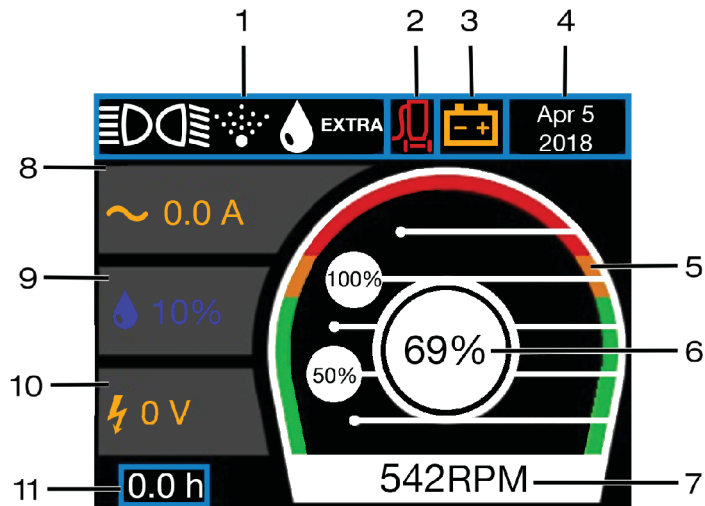

G004768









No.	Function	Description		
1	On / Off	To start / stop the machine		
2	Information Panel	See Information Panel page 24 .		
3	Menu Buttons	Menu		
4		Right / Left – Menu navigation as well as changing the menu navigation.		
5		Up / Down – Menu navigation as well as Night Panel on / off.		
6		OK – Menu navigation as well as zeroing the trip meter on long press.		
7		Back		
8	Mist Cooler System	On / Off		
9	Water Supply	On / Off		
10	Water quantity	Increase or Decrease	Mist Cooler System	Low. Norm. High
			Water Supply	0% — 100%
11	USB Port	E.g. Mobile phone charging		
12	Accessories	See the instructions for accessories		
13	Vacuum Clean Control	See the instructions for accessories		
14				
15	EXTRA	On / Off		
16	Emergency stop	See Emergency Stop Switch page 38 .		
17	Grinding Speed	Increase or decrease the grinding speed.		
18	Grinding Direction	Clockwise / Anticlockwise.		
19	Grinding	Start / Stop.		

4.4 Information Panel



G004770







No.	Symbol	Name	Explanation
1		Accessories	Lit when the accessory is activated.
		Accessories	Lit when the accessory is activated.
		Mist Cooler System	Lit when the Mist Cooler System is active. Changes colour to yellow when the water level in the tank is low.
		Water Supply	Lit when the water supply is active.
	EXTRA	Extra	Lit when the output Extra is active.
2		Vacuum Clean Control	See the instructions for accessories
3		Service	Service shines orange 50 h or 2 weeks prior to service. Turns red when the service interval has passed.
		Warning	Warning symbol is lit when warning or fault occurs. Symbol indicates type of fault.
4		Time	Shows time and date.
5		Power Meter – Available power	Show the amount of power available.
6		Power Meter – Power used	The level indicator and the ring around the value change colour depending on how much of the available power is being used. <ul style="list-style-type: none"> • Green = Ok • Yellow = low overload • Red = high overload
7		Grinding Speed	Shows the rotational speed of the grinding discs

No.	Symbol	Name	Explanation
8		Current	Shows motor current.
		Flow	Shows flow (m ³ or cfm), turns yellow when the flow is low.
		Pressure	Shows pressure (total pressure mbar or mm/Aq), turns yellow when the negative pressure is too large, suction blocked. Risk for the motor switching off due to overheating.
		Filter status	0% = clean Filter 100% = Blocked filter, yellow bar, time to clean the filter
9		Overload / Overload Protection	Overload indication, warns at 90%. The machine switches off at 100%.
		Mist Cooler System	Shows the quantity of water. Low. Norm. High. 0% - 100%
		Water Supply	
10		Voltage	Shows the mains voltage.
11		Operation Gauge	Shows operating time h and energy kWh.

4.5 Connection Panel



G004772

Symbol	Connection for
	Control panel
	Cooling fan
	CAN bus
	Mist Cooler System
	Accessories
	Water supply valve

5 Operation

5.1 General

The following section describes how to change tools and how to operate the grinding machine. This section does not deal with the technical aspects of grinding, such as selection of grinding tools, etc.

For choice of tool, go to HTC's website www.htc-floorsystems.com for more information.

5.2 Handle setting



WARNING

Risk of crushing.

Risk for personal injury.



NOTE

Ensure that the handle lock locks properly in the position wanted when adjusting the handle.

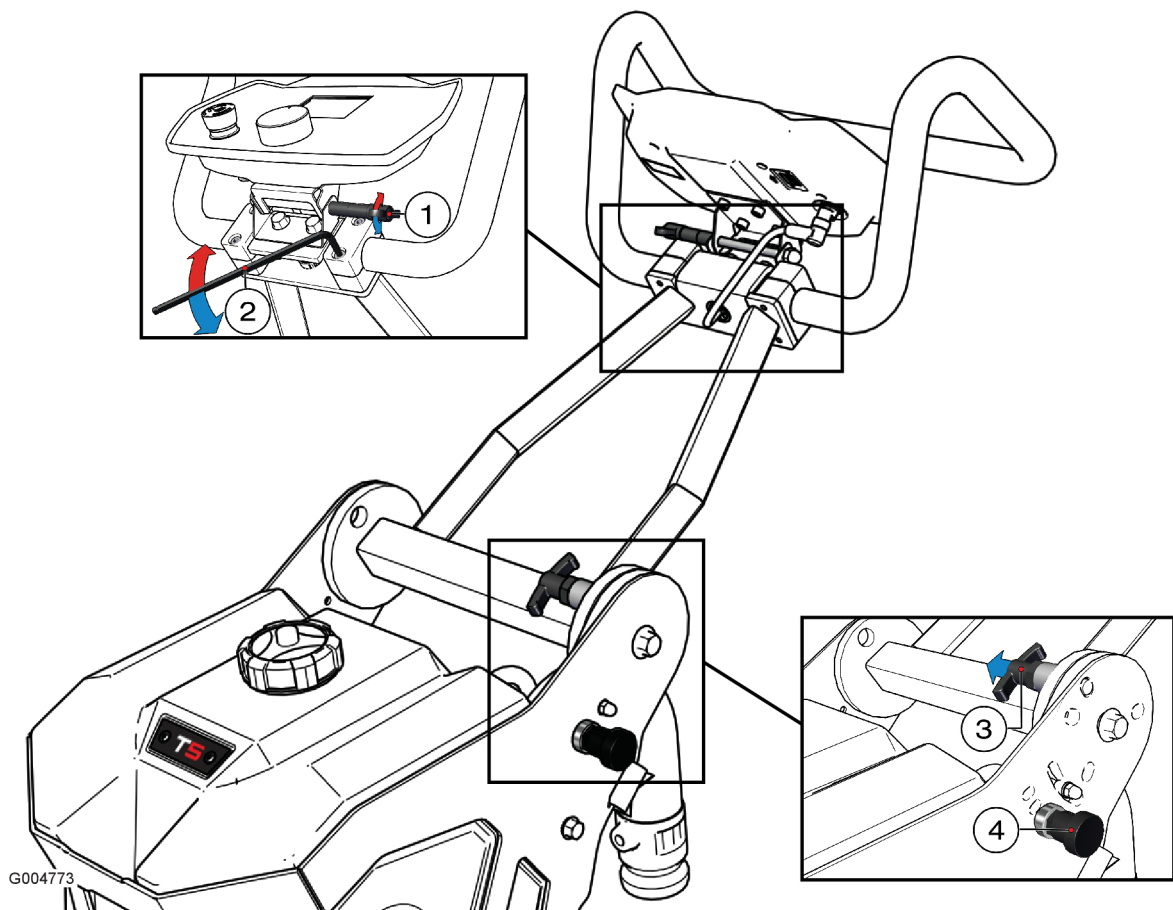

No.	Description
1	HMI adjustment
2	Handle adjustment, using 5 mm Allen key
3	Handlebar rough adjustment
4	Handlebar fine adjustment

Place in the right working height using the various settings.

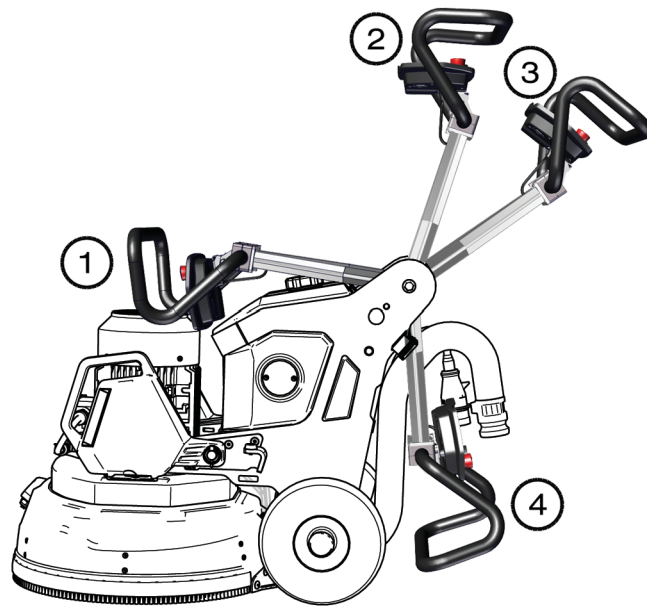

G004774

No.	Description
1	Handle position 1
2	Handle position 2
3	Handle position 3
4	Handle position 4

5.3 Handling weights

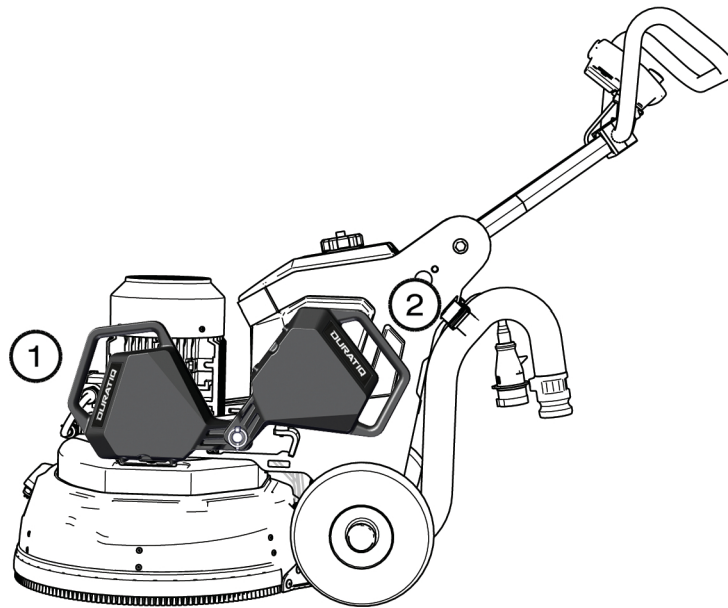

G004784

No.	Weights in the different positions
1	Weight position 1
2	Weight position 2

In order for the grinding pressure to be maximised, the weights shall be placed in position 1 and to be minimised in position 2, see page 31 and Technical Data.

The machine can be equipped with two weights, making it easy to move the centre of gravity of the machine.

It is also possible to remove the weights by removing the locking pin with a simple manual manoeuvre.

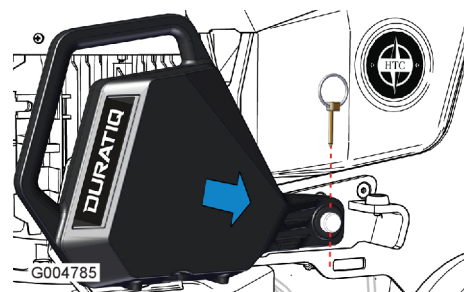

WARNING

Risk of crushing.
 Risk for personal injury.

**TIP**

If the machine is heavy to operate, it may be due to the placing of the weights. Fold the weights back to unload the grinding head.

If the machine feels heavy to operate, it may be due to the placing of the weights. Raise the weights to position 2 to unload the grinding head. Ensure that the weights are in the same position on both sides to prevent the risk of uneven grinding.

5.4 Cable and Hose Strain Relief Device

There is a cable and hose strain relief device located on the rear of the chassis.

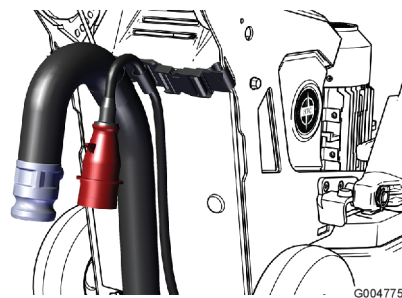

5.5 Separate grinding head and chassis

Remove cable and hose strain relief device from the chassis.

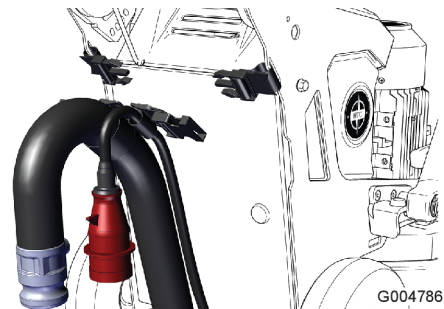

Place the weights in position 2.

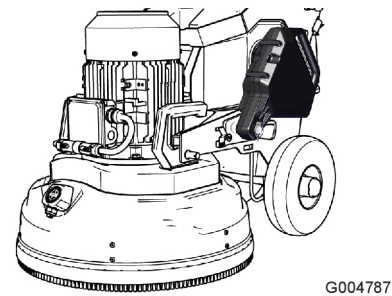

Disconnect the motor cable. Make sure that the chassis does not fall backwards when you then remove the pins holding the grinding head.

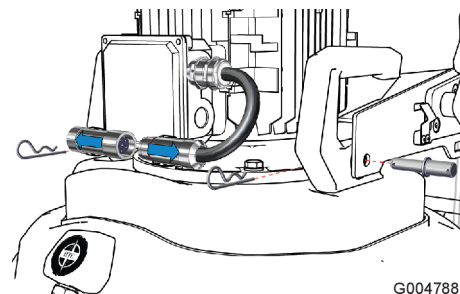

Lower the chassis to the floor.

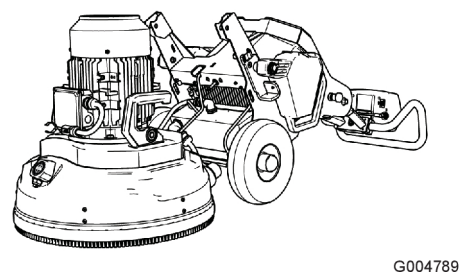

Remove the water hoses by (1) pressing the locking device in and (2) pulling the hose out.

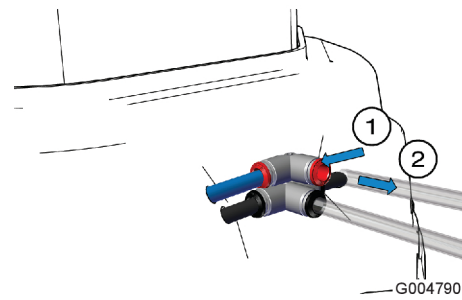

Now the chassis and grinding head are separated, making transport, or other movement, easier.

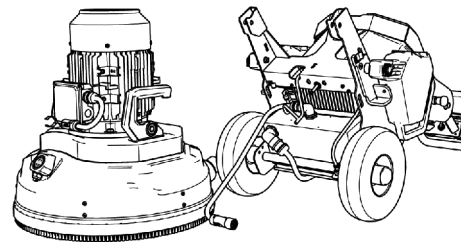

5.6 Access to Grinding Tools

Raise the handle to the second position, according to the Handle Settings page 30.

Lower the weights backwards, according to Handling weights page 30.

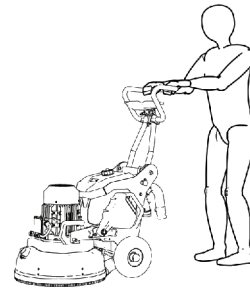

G004792

Tip the machine backwards.

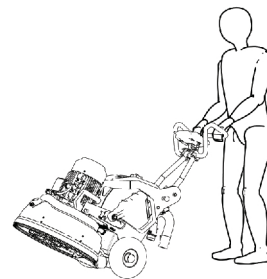

G004793

Make sure that neither the connection cable nor the dust connection get caught.

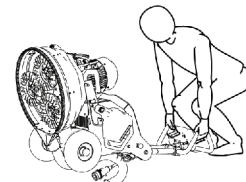

G004794

5.7 Fitting Grinding Tools



WARNING

High Temperature
Risk for Dust

**NOTE**

Let the dust extractor run while changing tools.

**NOTE**

Note the direction of rotation of the grinding discs.

Slide the new grinding tool diagonally, from above, down into the appropriate guide slot on the tool holder. Then push the tool fully into the guide slot.

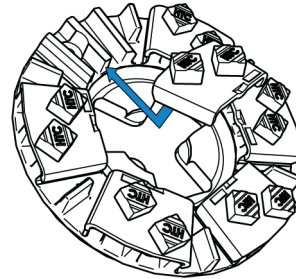

G004820

Lock the grinding tool into the tool holder by giving it a few light taps with a hammer.

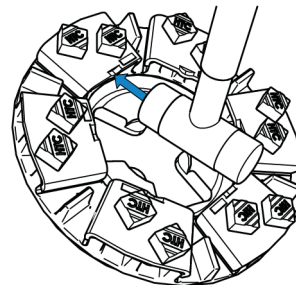

G004818

When changing the grinding tool, loosen it by giving it a few light taps with a hammer so the locking mechanism releases. Then draw the tool up out of the guide slot.

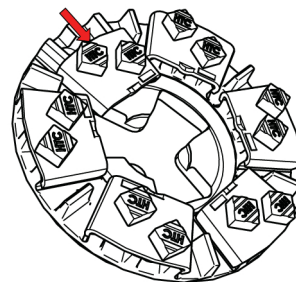

G004819

6 Grinding

Connect a dust extractor to the machine. For available models of dust extractors, go to HTC's website www.htc-floorsystems.com for more information.

Place the handle to the working position, see page 30.



WARNING

Risk for personal injury.

Do not let the cable come into contact with the rotating tools.



NOTE

Inspect the floor carefully and remove any objects sticking up, such as, for example, reinforcement rods or bolts, and any debris that could get stuck in the machine or be thrown out.

6.1 Grinding by machine



G004811

Make sure the emergency stop switch (1) is not activated. If not, turn clockwise according to arrows on the switch.

Press the button *on/off* (2) if the screen is switched off.

Start the dust extractor, if dry grinding is to be done.

Choose direction of rotation (3).

Set the speed for the grinding discs using the knob (4).

Start the grinding by pressing on (5).

When the machine is not in use, press on/off for 3 seconds, to switch the machine off.

6.2 Emergency Stop Switch

The emergency stop switch should only be used in an emergency, because it shortens the service life of the machine's electrical components.

When the emergency stop switch is pressed, the power to all electrical moving parts on the machine is turned off. Reset by turning the switch clockwise. The machine can then be restarted.

6.3 Making Operation Easier



WARNING

Risk for personal injury.

Do not let the cable come into contact with the rotating tools.



TIP

By arranging the hose and cable as shown in the picture, you avoid disruptive stoppages caused by having to re-position the cable and hose.

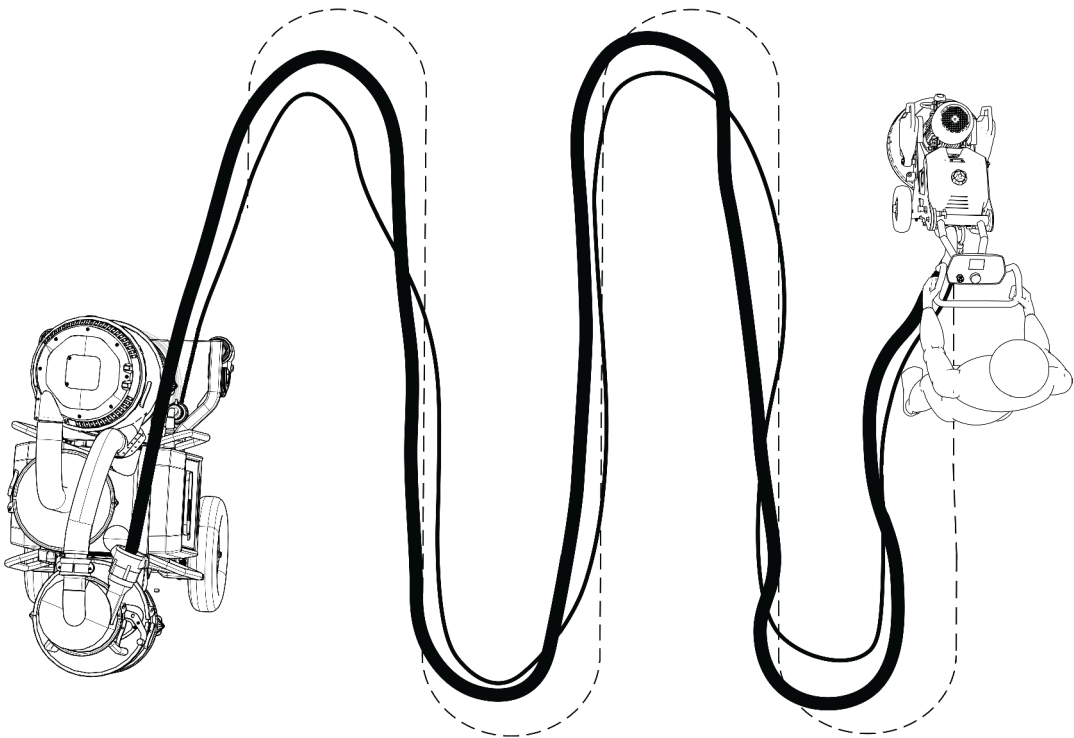

G004796

6.4 DURATIQ Remote connectivity

With DURATIQ Remote Connectivity, you can connect the grinder and dust extractor. DURATIQ Remote Connectivity is an accessory for the dust extractor. To pair the DURATIQ grinder and dust extractor, do as follows: go to DURATIQ Remote in the menu.

Start with your dust extractor. Press the *Main menu* button, and select using the arrow keys *Settings* and then *Duratiq Remote* respectively.

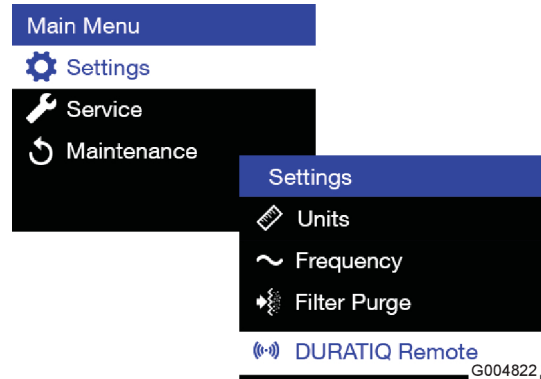

Then, go to *Remote On/Off* and select *Enable* and press OK.

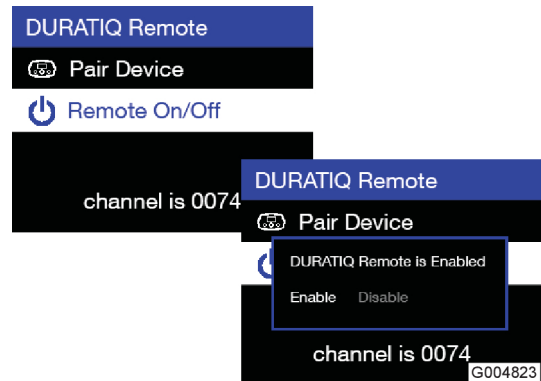

Go to *Pair Device* and press OK.

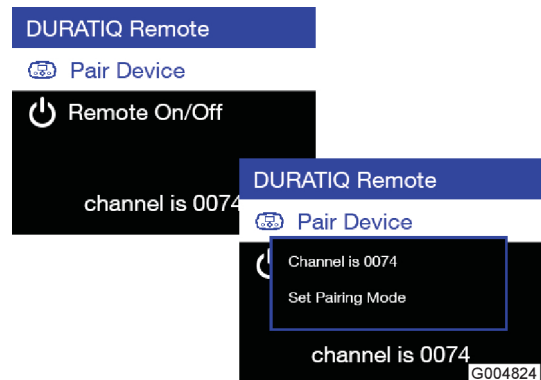

Now, continue with the grinder. Press the *Main menu* button, and select using the arrow keys *DURATIQ Remote* respectively.

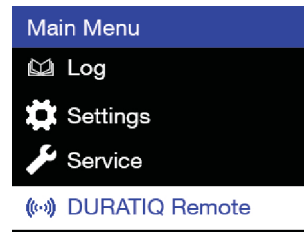

G004825

Go to *Remote On/Off* respectively. Select *Enable* and press OK.

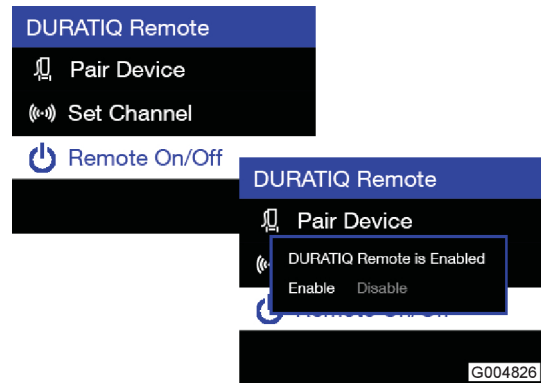

Go to *Set Channel* respectively. Each grinder/dust extractor pair needs to have its own channel for communication. Select a channel with the arrow keys and press OK.

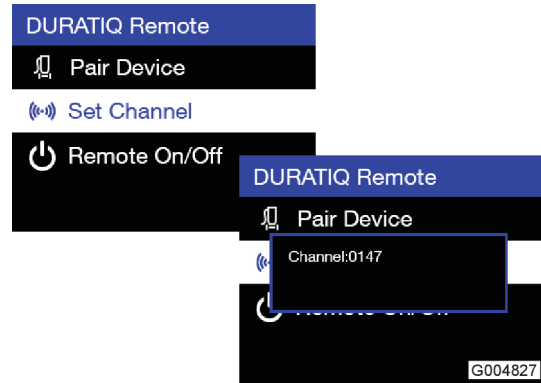

Go to *Pair Device* respectively. The machine now starts to search for units nearby.

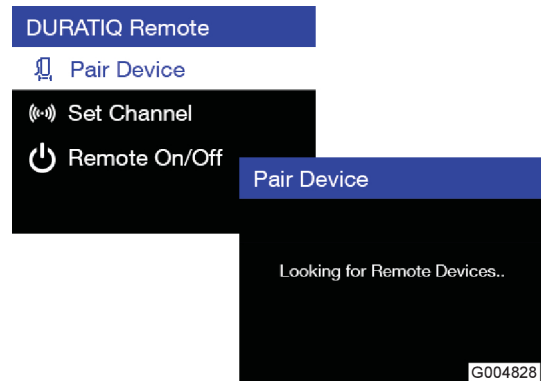

Select unit from list and press OK. A message appears saying that the units are paired.

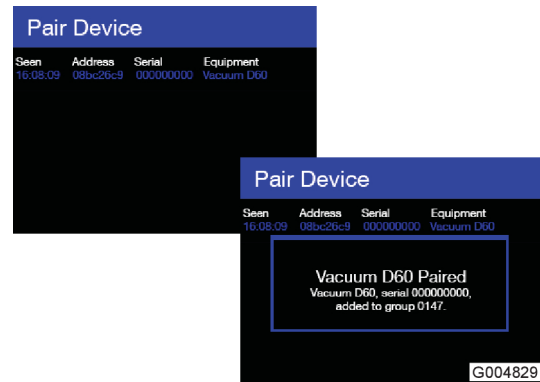

The communication between the dust extractor and the grinder is now ready. You can now control start/stop and filter cleaning with the buttons on your grinder.

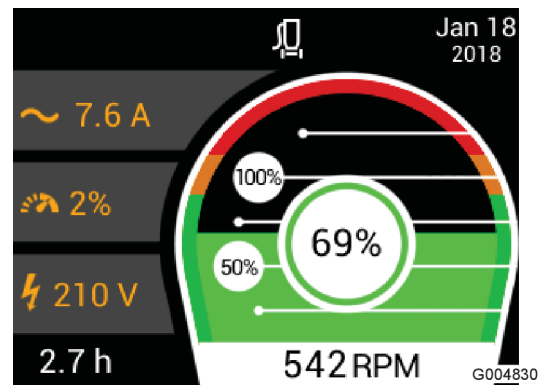

Symbol	Description
	The dust extractor is linked but not started
	The dust extractor is linked and started
	The dust extractor shows a warning on its display.
	The dust extractor shows an error message on its display.

On the grinder's display, you can now see flow, negative pressure or filter status. You can choose between them by using the left arrow button. If the machine is equipped with remote control, the information is also available here. May need updating the software in the remote control. Contact your retailer or service.

If there should be any problem with the communication, or if it is not possible to pair the units, there may be something interfering with the frequency you are using. Try with a different channel.

7 Accessories

7.1 Water package

7.1.1 Mist Cooler System

Machines from HTC can be equipped with the Mist Cooler System for efficient cooling of the grinding tools. The Mist Cooler System is also available as complementary equipment and can be ordered afterwards.

The Mist Cooler System creates a very finely divided water mist that is distributed on the floor surface through a nozzle. The system is used to obtain a better performance during grinding, while it is possible to grind dry and use a standard dust extractor for the dust that arises. This cools the tools and makes grinding more effective. The Mist Cooler System reduces the risk of the diamond tools "glazing over".

Under *Menu — Settings — Operation* you can set an auto mode, which allows the Mist Cooler System to switch off when the grinding is switched off.

The system uses the water in the tank. When the water level is low, the mist symbol changes colour to yellow.

Grinding

Fill the tank with cold water.



G004779

Start the Mist Cooler System by pressing the button on the control panel, Control panel (HMI) page 22 position 8. When the system is active, the symbol on the display for the Mist Cooler System is lit. See Information Panel page 24 position 1.

The water quantity can be adjusted using the +/- buttons, see Control panel (HMI) page 22.



G004780

Switch off the Mist Cooler System by pressing the Mist Cooler System button on the control panel. See Control panel (HMI) page 22 position 8.

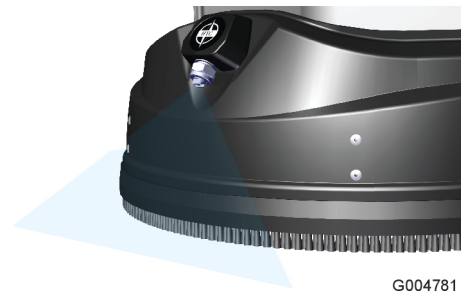

7.1.2 Wet grinding



NOTE

Make sure the water supply is only on during grinding. Always use liquid suction when wet grinding.

Wet grinding with water is used when grinding difficult to grind floors. It is also used to obtain a greater performance or lower temperature during grinding.

Grinding

Set the handle to the working position. See page 30.

Connect the water using the quick release coupling on the rear of the machine. For pressure and maximum flows, see Technical Data page 56.

An electrically controlled proportional valve controls the water flow.

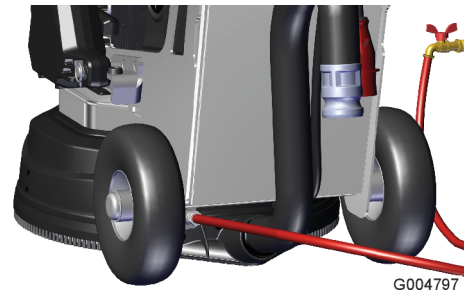

Start the water flow by pressing the button on the control panel, see Control panel (HMI) page 22 position 10. Increase and decrease the water flow using + and - respectively.



G004798

The water is outputted via slits in the hose under the cover.

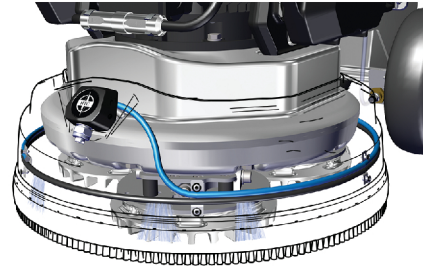

G004799

8 Maintenance and repair

For the HTC Support website, scan the QR code with a mobile phone with Internet access or go to:

<http://www.htc-floorsystems.com/support/>.

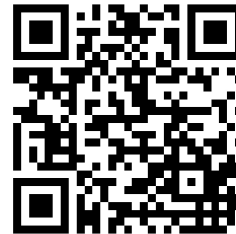

G003236

8.1 General



WARNING

Moving parts.

Risk for personal injury.

Always use the recommended personal protective equipment.



WARNING

Electrical current.

Risk for personal injury and mechanical damage.

Disconnect the power prior to cleaning, maintenance, change of tools and repair.

8.2 Cleaning



NOTE

Risk for mechanical damage.

During cleaning, only use cold water without chemicals.

Only use high-pressure washer on grinding head.

- Always clean the machine after use. Only use high-pressure washer on grinding head and hose and sponge on the rest of the machine.

- Vacuum clean the electrical cabinet, cooling fan and cooling flange.

8.3 Prior to each new grinding process

- Check the tool holder and grinding holder to ensure that no damage or cracks have arisen. Replace parts, if there is any damage.

8.4 During operation

- Check that there are no abnormal vibrations or noises.

8.5 Daily

- Check the emergency stop function.
- Check the radio's emergency stop function.
- Check for wear to the grinding tools – abnormal or uneven wear may indicate a damaged grinding holder.
- Check the tool holder and grinding holder to ensure that no damage has arisen. Replace the parts, if there is any damage.
- Check the connection of hose and cables. Adjust if necessary.

8.6 Every week

- Clean machine and remote control.
- Check the handle's three different locking functions. Replace the bushes, if necessary.
- Check the locking function of the weights and the function of the positioning blocks, replace if necessary.
- Check warning decal.
- Check the fastening between chassis and grinding head – gap, wear, dry cracks. Replace the bushes, if necessary.
- Check the grinding cover – seal, wear, cracks, brush list, extraction, hoses, couplings.
- Electrical cabinet – check seals.
- Electrical cables – check wear and attachment.

8.7 Repairs

All repairs that may need to be performed must be done by one of the HTC authorised service centres. Contact your retailer if your machine requires servicing. For contact information, consult the start of the manual and also **www.htc-floorsystems.com**.

8.8 Spare parts

To ensure rapid delivery of spare parts, always specify the model, the machine's serial number and the spare part number when ordering.

Information on the model and serial number can be found on the machine's name plate.

Information on spare part numbers can be found in the machine's spare parts list, which is available to read or print out from the enclosed digital media. If you have any questions, please contact your nearest HTC retailer.

Only original tools and spare parts from HTC may be used. Otherwise, the warranty will be invalid.

8.9 Warranty

In order for the warranty to be valid, only original HTC parts should be used.

9 Troubleshooting

9.1 General

This chapter describes faults that may occur and how to deal with these faults. If the faults cannot be dealt with, or if there are other faults, contact your nearest retailer. For contact information, see the start of the manual.

Fault description	Cause	Instruction user
Fault code is shown in HMI.	One of the machine's alarm systems has been activated.	For more information see Warnings and Error Messages.
The machine loses contact with other units.	The CAN bus signal is broken.	Check cable connections on the connection panel.

9.2 The machine will not start

Error source	Cause	Instruction user
Electrical supply	Fault on supply, e.g. fuses, earth fault breakers or connecting cables	Check correct voltage on incoming phase/phases.
Power supply	Power supply indication is not lit	Check miniature circuit breaker F1.
Mainboard	Main circuit board is not lit	Check fuse F2, red LED.
Fuse	Standby LED on the control panel Panel is not lit	

9.3 Fuse or earth fault breaker trip frequently

Fault description	Cause	Instruction user
Earth fault breaker trips.	Too high a leakage current/earth fault.	Check cabling in cabinet and splice cable. Check earth fault breaker trip. Check that it is an A or B and not an AC earth fault breaker trip.
Fuse trips.	Too high a load or too small fuses	<p>Check size of fuses and inertia.</p> <p>Reduce the machine's load by reducing the grinding pressure, lower the revs per minute or by changing tool. See the machine's power meter.</p>

9.4 The machine cannot cope

Fault description	Cause	Instruction user
The machine cannot cope	Too high a load	Reduce the grinding pressure.
		If the machine runs at high speed, lower the revs per minute so the machine becomes stronger. See meter for available power.
		Voltage drop, check the voltage meter during grinding.
		Too sticky a coating on the surface being processed. Run half of the machine on the surface to be cleaned and half on the clean surface. This removes any residue from the tools.
		Check the tools. Ensure that the correct tools are used, that they are in working order and that they are correctly fitted.

9.5 Warnings and Error Messages







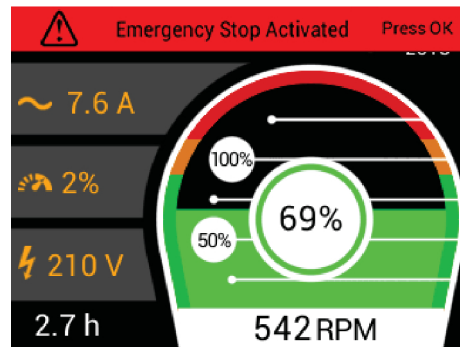

9.5.1 Warnings

The error messages and warnings are shown on the display on the machine. A warning message is displayed on the display with a yellow field, the machine can still be used. If the warning is known, the field shows a warning symbol as well as a description for the specific warning. See error codes Error Messages page 54. Press OK to erase the field. A small warning symbol will continue to be visible in the symbol field as long as the warning is active. The warning is registered in the machine's log.

An error message is displayed in red on the display, the machine stops. If the error is known, the field shows a warning symbol as well as a description for the specific error. See error codes and Error Messages page 54. Press *OK* to attempt to reset the error. The error is registered in the machine's log.















G004800

Symbol	Warning	Fault description	Action
	CONTROL VOLTAGE LOW	Low control voltage.	Check PSU.
	GENERIC INVERTER WARNING (error code)	Converter indicates error.	Go to the HTC Support website.
	HEATSINK TEMPERATURE HIGH	Frequency converter overheats.	Fans are not standard. Recommended for ambient temperatures >30°C. Check the function of the fans. Clean fans/cooling flange. Check voltage level during operation. Reduce the grinding power.
	MOTOR OVERLOAD	Grinding motor overloaded. Overload meter exceeds 90%.	Reduce the motor's load, see meter for motor current.
	MOTOR TEMPERATURE HIGH	Grinding motor overheats.	Check the motor's cooling fan. Reduce the motor's load, see meter for motor current.
	POWER UNIT TEMPERATURE HIGH	High temperature in electrical cabinet.	Fans are not standard. Recommended for ambient temperatures >30°C. Clean fans and cooling flange. Check that the fans are rotating (rotating during grinding and 1 min after finished grinding as well as when needed). Let the machine cool down.
	SERVICE	Machine service.	Book service at Authorised Workshop.
	WATER LEVEL LOW	Low water level in tank.	Top up water. Check level sensor.

Symbol	Warning	Fault description	Action
	VOLTAGE LOW	Low input voltage to machine.	Check voltage level during operation. Check cable area. Check electrical supply.

9.5.2 Error Messages

Symbol	Error Message	Fault description	Action
	CANBUS ERROR	Error on CAN bus.	Check cabling. Check units connected to HMI.
	EMERGENCY STOP ACTIVATED	Emergency stop activated.	Reset emergency stop.
	GENERIC INVERTOR ERROR	Generic error converter.	Go to www.htc-floorsystem.com and select support.
	GENERIC..... ERROR (error code)	Generic error converter.	Go to www.htc-floorsystem.com and select support.
	HEATSINK TEMPERATURE HIGH	Cooling flange for frequency converter is overheated.	Fans are not standard. Recommended for ambient temperatures >30°C. Let the frequency converter cool down.
	INVERTER OVERLOAD	The converter is overloaded.	Let the machine cool down.
	MOTOR NOT CONNECTED	Break in grinding motor/grinding motor cabling.	Check grinding motor cabling. Check measure grinding motor.
	MOTOR OVERHEAT	Grinding motor is overheated.	Let the motor cool down.
	MOTOR OVERLOAD	Grinding motor becomes overloaded. Overload meter up to 100%.	Let the machine cool down.
	MOTOR SHORT CIRCUIT	Grinding motor short-circuited.	Check grinding motor cabling. Insulation measure grinding motor.

Symbol	Error Message	Fault description	Action
	OVERVOLTAGE	Input voltage too high.	Error on incoming supply.
	PHASE LOSS	Phase error incoming supply.	Incoming supply has lost one or more phases. Check incoming supply.
	UNDERVOLTAGE	Low voltage.	Check cable area and cable length. Error on incoming supply. Emergency stop activated.

10 Technical Data

	DURATIQ T5				
	140502	140503	140504	140505	140506
Output	2.2 kW / 3 hp	4 kW / 5 hp			
Recommended fuse size (time-lag)	13 A	30 A	16 A	10 A	
Frequency	50—60 Hz ±10%				
Voltage	1x200-240 V ±10%	1x200-240 V ±10%	3x200-240 V ±10%	3x380-415 V ±10%	3x440-480 V ±10%
Control voltage	24 VDC				
Total machine weight	122 kg 269 lbs	179 kg 395 lbs		178 kg 392 lbs	
Weight, weights	Accessories	2x20 kg 2x44 lbs			
Grinding pressure without weights	70 kg 154 lbs	78 kg 172 lbs			
Grinding pressure, weight position 1	108 kg 238 lbs	119 kg 262 lbs			
Grinding pressure, weight position 2	80 kg 176 lbs	88 kg 194 lbs			
Grinding diameter	515 mm 20"				
Grinding discs	3 x Ø230 mm 3 x Ø9"				
RPM, grinding discs	360 — 1200 rpm				
Recommended minimum cable area	2.5 mm ² 14 AWG	6 mm ² 10 AWG	2.5 mm ² 14 AWG	2.5 mm ² 14 AWG	
Storage temperature (short time e.g. transport)	-20 — +60° C -4 — +140° F				
Working temp.	-10 — +40° C +14 — +104° F				
Humidity	Max. 95% but no condensation				

	DURATIQ T5				
	140502	140503	140504	140505	140506
Sound pressure level, according to ISO 11202	74 - 87 dB (A)	77 - 90 dB (A)			
Sound power level, according to ISO 11202	85 - 98 dB (A)	88 - 100 dB (A)			
Vibrations, Floor preparation (T-Rex)	2.25 m/s ²	2.92 m/s ²			
Permitted daily exposure, Floor preparation (T-Rex)	> 10 h				

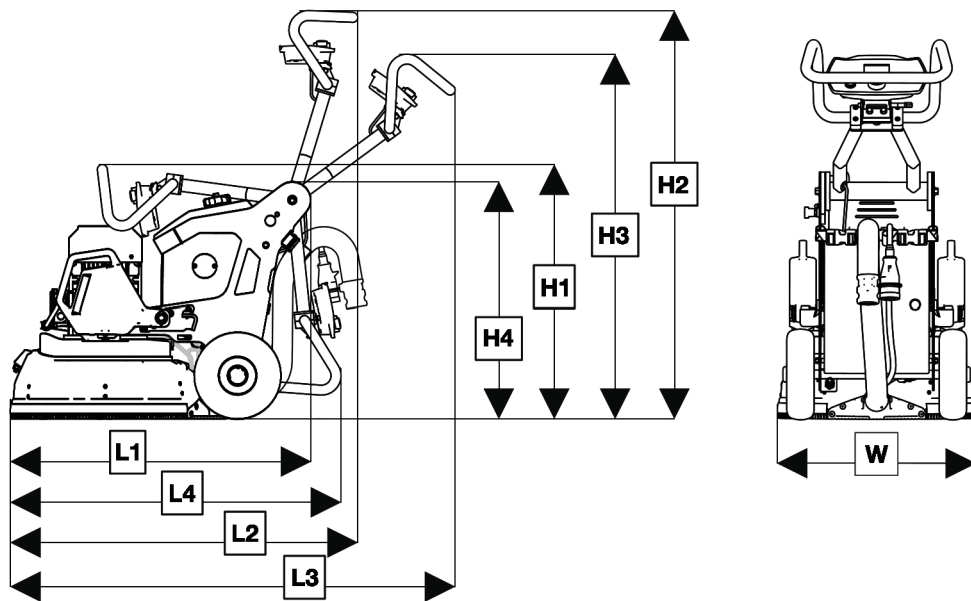

G004759

Handle position	Length		Height		Width	
	Label	mm / inch	Label	mm / inch	Value	Value
1	L1	870 mm / 34.3 inch	H1	720 mm / 28.4 inch	W	569 mm
2	L2	940 mm / 37 inch	H2	1240 mm / 48.8 inch		
3	L3	1260 mm / 49.6 inch	H3	1030 mm / 40.5 inch		22.4 inch
4	L4	1000 mm / 39.4 inch	H4	720 mm / 28.4 inch		

11 Environment

HTC's products are constructed mainly of recyclable metal and plastic. The main materials used are listed below.

11.1 Chassis

Machine part	Material	Waste management
Chassis	Metal	Metal recycling ¹⁾
Handle	Plastic covered steel	Metal recycling ¹⁾
Wheels	Rubber, PUR	Metal recycling / Combustible
Cover	Plastic, ABS	Combustible
Fixed parts	Metal	Metal recycling ¹⁾
Hose connections	Metal, aluminium	Metal recycling ¹⁾
Hoses	Plastic, PUR and PVC	Combustible
Support blocks	Plastic, POM	Combustible
Hose guide	Plastic, PP/PA	Combustible

¹⁾ If possible, different metals should be separated.

11.2 Grinding head

Machine part	Material	Waste management
Housing halves	Aluminium	Metal recycling ¹⁾
Grinding cover	Plastic, ABS and TPU	Plastic recycling / Combustible
Other components	Steel	Metal recycling ¹⁾

¹⁾ If possible, different metals should be separated.

11.3 Electrical system

Machine part	Material	Waste management
Control cabinet	Steel	Metal recycling ¹⁾
Cables	Copper conductors with PVC / Nylon covering	Metal recycling ¹⁾
Electrical components		Electronic waste

1) If possible, different metals should be separated.

11.4 Recycling

The machine or machine components can be returned to HTC Sweden AB.



G003127

The machine or machine components can be returned to HTC Sweden AB. For recycling and scrapping of components, see the applicable national regulations for each country. Used electrical and electronic products, including all types of batteries, are to be left at dedicated collection points for recycling (according to Directive 2012/19/EU and 2006/66/EC).

HTC Sweden AB
Box 69
614 22 Söderköping
Sweden

Visiting address:
Klevvägen 7
614 92 Söderköping
Sweden

Phone: +46 (0)121 294 00
Fax: +46 (0)121 152 12
E-mail: info@htc-sweden.com
www.htc-floorsystems.com

